

AARTONMOUNTS LCD BRACKET NUMBER 3019F

1. Part List

No.	Name of part	Material	Amount
A	Wall plate	Q215	1
B	Left hooking plate	Groupware	1
C	Right hooking plate	Groupware	1
D	lag bolts	Standard part	6
E	plastic anchors	Standard part	6
F	M5 washer	Standard part	4
G	M6 washer	Standard part	12
H	M8 washer	Standard part	6
I	M5 lock washer	Standard part	4
J	M6 lock washer	Standard part	4
K	M8 lock washer	Standard part	4
L	M8 Spacer	PA	4
M	M5*15 Phillips screw	Standard part	4
N	M5*30 Phillips screw	Standard part	4
O	M6*15 Phillips screw	Standard part	4
P	M6*30Phillips screw	Standard part	4
Q	M8*15 Phillips screw	Standard part	4
R	M8*30 Phillips screw	Standard part	4

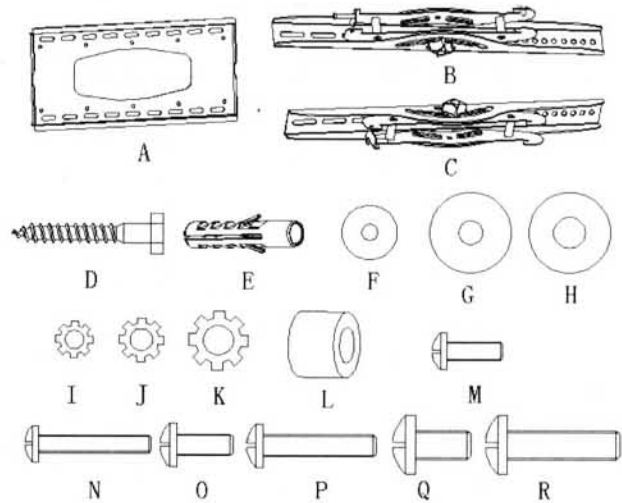

2. Name of parts

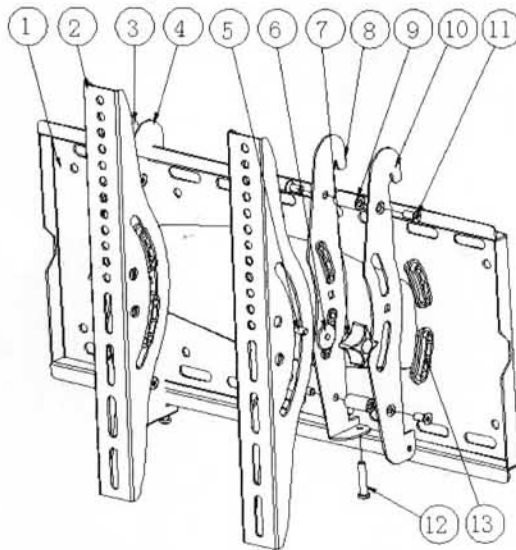

Item NO.	Symbol	Name	Material	Amount	Remark
1	LCD-806-03	Wall dead plate	Q215	1	$\delta=2$
2	LCD-806-01	TV hooking plate	Q215	2	$\delta=2$
3	LCD-805-03	Joint plate 1	Q215	1	$\delta=2$
4	LCD-805-04	Joint plate 2	Q215	1	$\delta=2$
5	M6*15	Square-necked screw	Standard part	2	
6	LCD-805-10	Plastic washer	ABS	2	
7	LCD-805-05	Knob	PA	2	
8	LCD-805-06	Joint plate 3	Q215	1	$\delta=2$
9	LCD-806-02	Joint sleeve	Q235	4	
10	LCD-805-08	Joint plate 4	Q215	1	$\delta=2$
11	M6*10	Phillips screw	Standard part	8	
12	M6*30	Phillips screw	Standard part	2	
13	LCD-805-09	Spacer block	PA	8	

3. Installation and operation instructions

Note: please read the instructions carefully before installation!

Step 1:

Use the wall dead plate as a templet to drill six holes of 10mm diameter and 50mm depth. Preferentially select the outer waist-like holes in the wall dead plate as the templet. The six holes should be symmetrical in horizontal and vertical directions. Insert six plastic anchors into the holes.

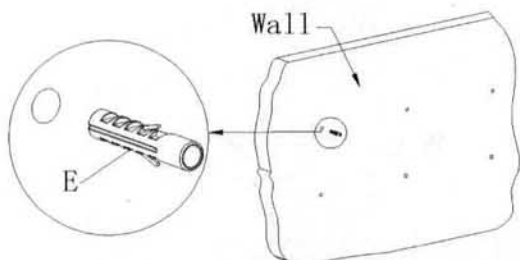

Step 2:

Screw 6 lag bolts into the 6 plastic anchors through the washer and the mounting holes on the wall fixed plate to fix the wall fixed plate on the wall tightly.

Note: The bolts should be screwed down.

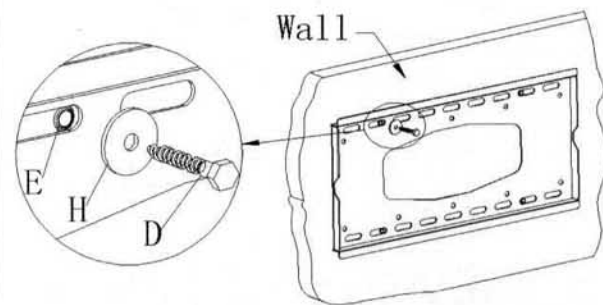

Step 3:

Install TV hooking plate on the back of TV: each TV hooking plate should be fixed with two screws. The distance from top of two hooking plate to the top of TV should be equal and install position of hooking plate should be as centre as possible. Please guarantee the TV hooking plate in the vertical direction. The knob should face outward. The fasteners should be selected according to the thread holes at the back of the TV.

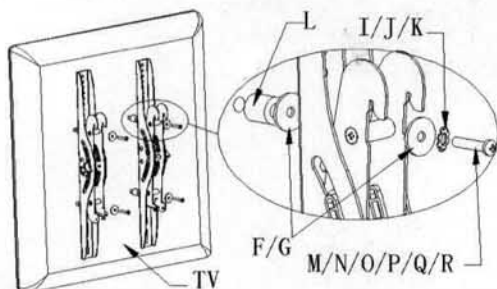

Step 4:

Fig 1: Hang two hooking plates on the wall dead plate fixed on the wall. Loosen hands until it hung firmly.

Fig 2: There has a screw under each hooking plate. Screw out it in a great measure before installation. After the underside of hooking plate is in his position, re-screw it to fix the hooking plate on the wall plate.

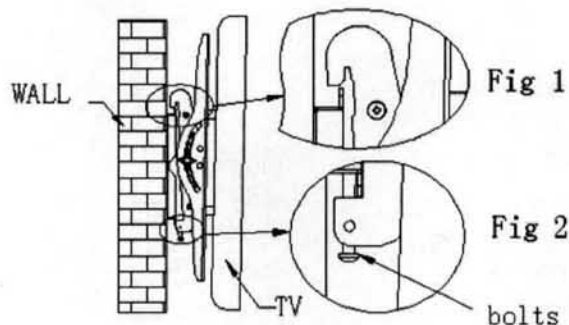

Step 5:

The knobs should be loosened before adjust the angle of view for the TV between -15° and $+15^{\circ}$. After the position has been determined, the knobs on both hooking plates must be screwed tightly. Then you can watch TV.

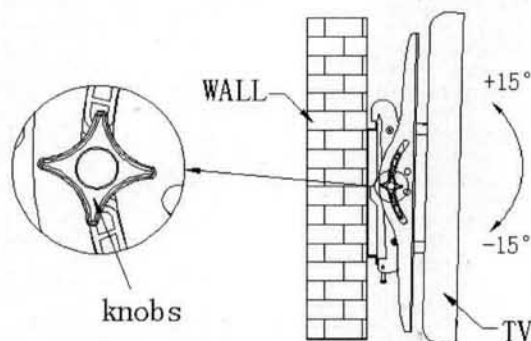

4. Notes

(1) The wall plate should be fixed on a solid concrete wall

(2) Must Be Fitted By A Professiona