

3802

INSTALLATION INSTRUCTIONS

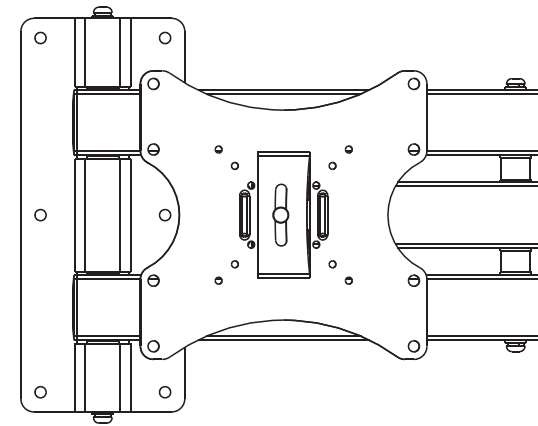

Pitching angle:
-20° ~ +20°
Swivel: 180°

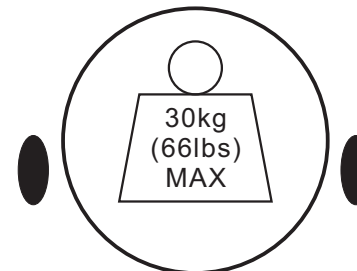

LCD Wall Mount

Max Load Capacity: 30kg(66lbs)

MUST BE FITTED BY A PROFESSIONAL

Component Checklist

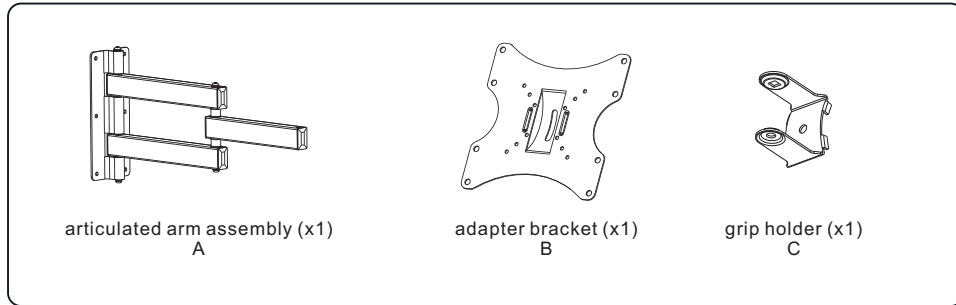

Package M

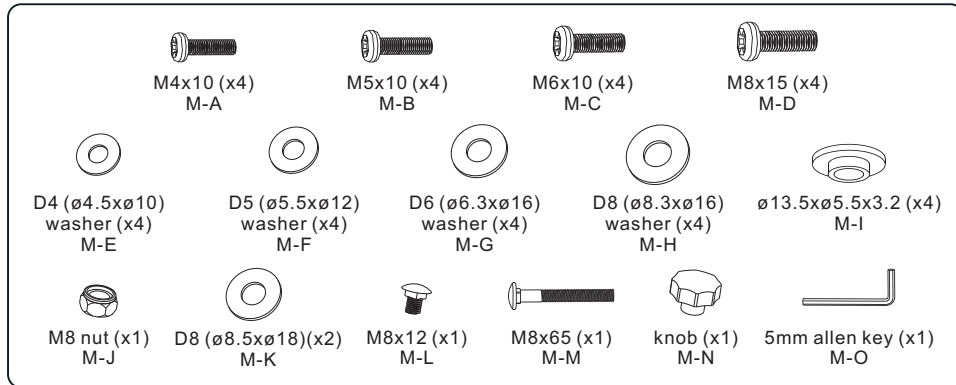

Package W

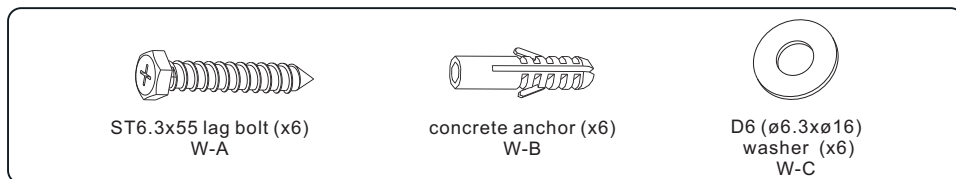

Tools required

- Phillips Head Screw driver(200mm length exclude the handle)
- M6 Socket and wrench
- Electric drill and 10mm masonry bit for concrete wall installation
- Marking Pen
- Hammer

- Use the Wall Plate as a template to mark six holes locations on the wall, as shown in fig. 1.1.
 - Pre-drill these holes with a 10mm masonry bit to at least 60mm in depth. Insert a Concrete Anchor (W-B) into each of these holes. Attach the Wall Plate to the wall using six wood screws (W-A) and six washers (W-C), as shown in fig.1.2.

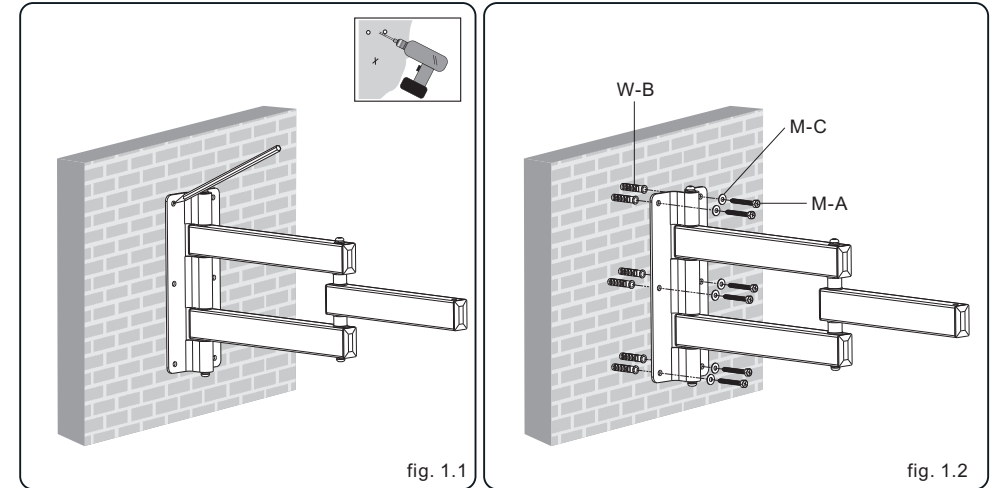

2 Assembling Adapter bracket

- Assemble the adapter bracket with the knob and the screw provided, tighten the knob and the screw as shown in fig.2.1.

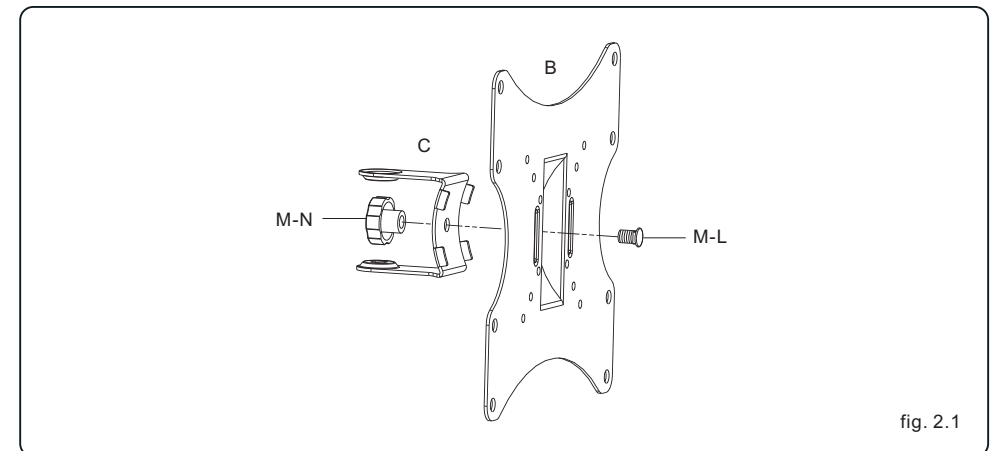

3 Installing Adapter Bracket

- To prevent scratching the screen, set a cloth on a flat, level surface that will support the weight of the screen.
- Place screen face side down. Place the adapter bracket on the back of screen, align to holes.
- Attach the adapter bracket to the back of the screen using appropriate combination of screws and washers as shown in fig.3.1 and fig.3.2.

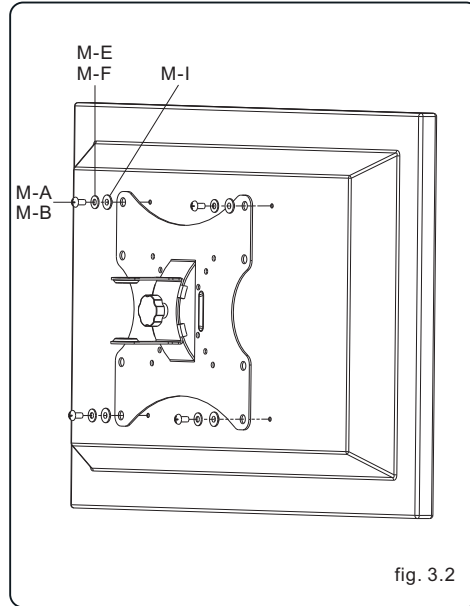
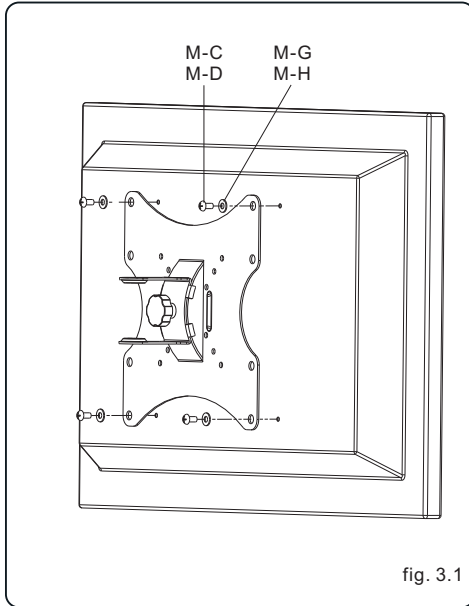

4 Installing the Bracket Mounted TV to the Wall Plate

Warning: A minimum of two qualified people are required for this operation.

- Assemble the bracket mounted TV to the wall plate with appropriate screw, washer and nut provided, tighten the screw and nut as shown in fig.4.1.

Note: You can tighten or loosen the allen screw use the 5mm allen key so that the cantilever arm can be precisely placed in the position when fully extended or laterally rotated.

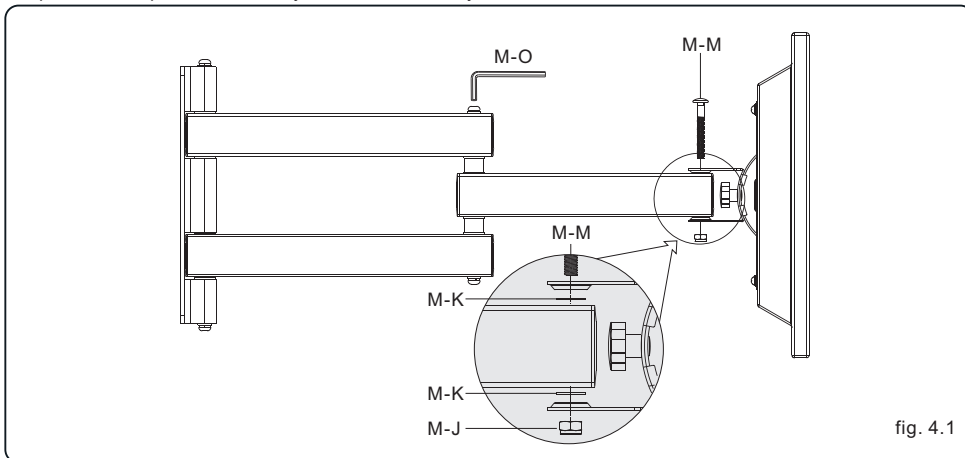

5 Pitching angle adjustment

- Use the tilt adjusting knob to adjust your TV to the desired angle, the pitching angle can be adjusted between -20° ~ 20° , as shown in fig 5.1.

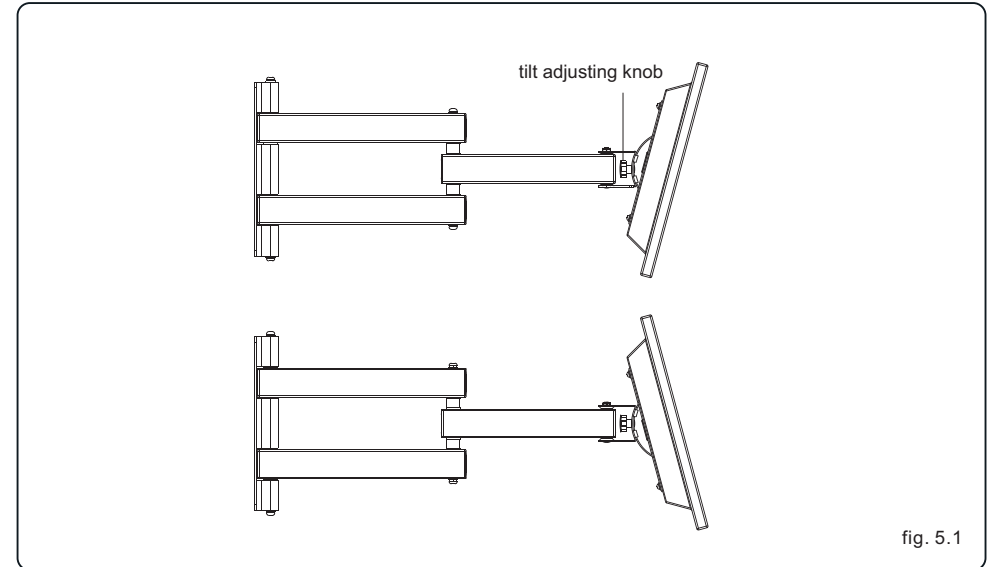

Maintenance

Once you have mounted the bracket and the flat screen, check that they are sufficiently secure and safe to use. You should check whether screws are fixed well each two months. If you have any doubts regarding the installation, please consult our retailer or service department for detail.

