

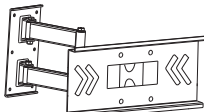

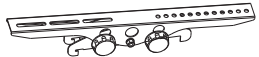







3546G

MUST BE FITTED BY A PROFESSIONAL

1		WALL PLATE & FRONT PLATE	x1
2		ARMS FOR TV	x2
3		SECURITY LOCKING BAR	x1
A		M6.5x65mm screw	x6
B		WALL PLUG	x6
C		M8x16mm Outer hexagonal screw	x4
D		M6x20mm Cross round screw	x4
E		Φ6 Plastic spacer	x4
F		Φ6X16 Plastic spacer	x4
G		Φ8 Plastic spacer	x4
H		SPIRIT LEVEL	x1
I		M8x16mm Cross round screw	x4

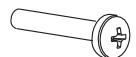
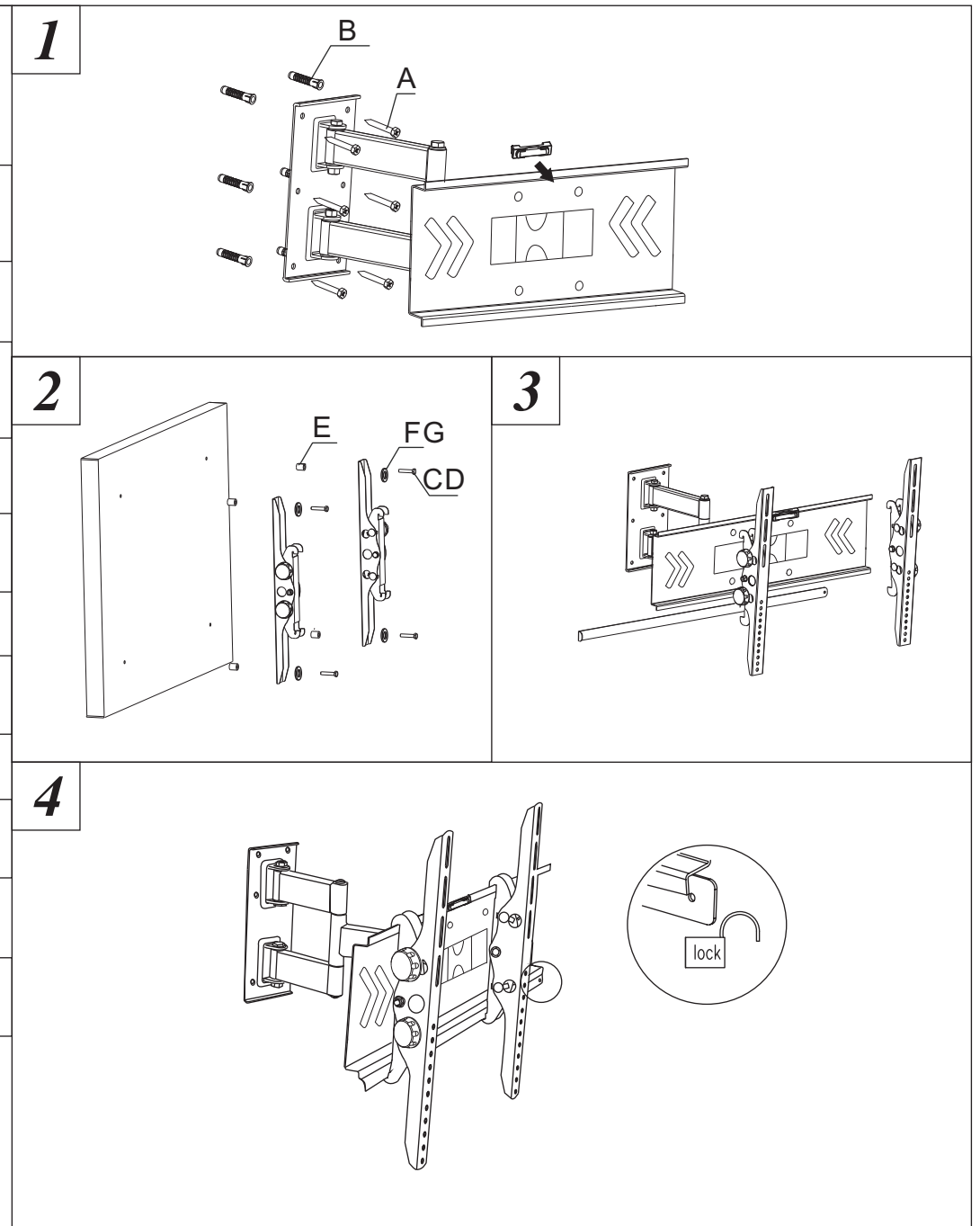

MUST BE FITTED BY A PROFESSIONAL